

HOME STAR - 500 W

MIXER GRINDER

BOROSIL[®]

Performs Beautifully



Q8203.



AK-J-5334466



USER MANUAL

HAMG500W22

READ ALL INSTRUCTIONS BEFORE USING THIS APPLIANCE

INTRODUCTION

Congratulations on your purchase of
BOROSIL HOME STAR 500 W MIXER GRINDER!

IMPORTANT SAFEGUARDS

When using electrical appliances, basic safety precautions should always be followed including the following:

Read all instructions before using the product.

- Use only 230V, 50Hz AC power supply.
- The mixer grinder is for household use only. Do not use outdoor or for commercial purposes.
- Do not operate the appliance if it has malfunctioned or has been damaged in any manner. Never try to repair the product by yourself. Contact our Customer Care No. **1800 224 552** OR **myborosil@borosil.com** for examination and repair.
- Do not let power cord hang over the edge of the table or counter, or touch hot surfaces.
- This appliance is not intended for usage by persons (including children) with reduced physical, sensory or mental capabilities, or lack of experience and knowledge, unless under supervision or given instructions concerning the usage of the appliance by a person responsible for their safety. Children should be supervised to ensure that they do not play with the appliance.
- Before using, place the appliance on an even, stable surface; operate according to the instructions given.
- Keep the mixer grinder at least 6" (150 mm) away from the walls for proper ventilation.
- Do not place the mixer grinder on a wet surface.
- Sufficient space should be available around the mixer grinder for keeping the various items and ingredients required.
- Always ensure that speed selector is at OFF position before fixing accessories.
- Never try to touch the moving parts or blades of the mixer grinder while in operation.
- The blades are sharp and should be handled very carefully. Wash them under running water and do not rub them by hand.
- Never operate the mixer grinder without the jar lid or dome in place.
- Always make sure the jar has been locked in the slot before operating.
- Never operate the mixer grinder without any load in the jar.
- Handle the jar and the main unit with care.
- Do not operate the appliance for other than its intended use.

DESCRIPTION OF PRODUCT

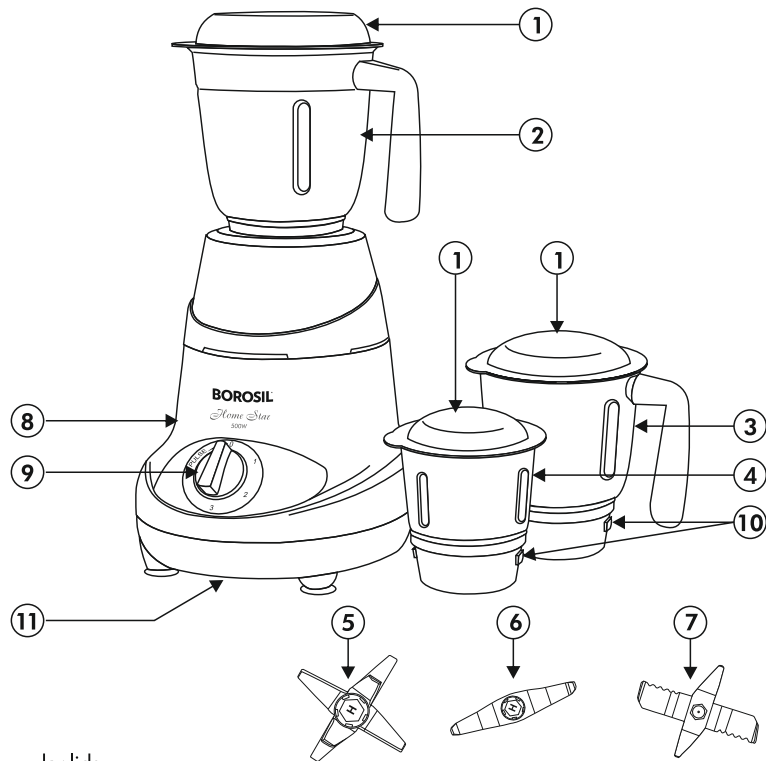

1. Jar lids
2. 1.2 Liter stainless steel jar for blending and mixing
3. 800 ml stainless steel jar for wet and dry grinding
4. 400 ml stainless steel jar for chutney/wet masala grinding
5. 6 leaf Liquidizing blade for blending jar
6. 2 leaf blade Multi purpose for blending / dry & wet grinding
7. Chutney grinding blade
8. Motor unit
9. 3-Speed dial with pulse function
10. Jar locking grooves
11. Overload protector switch

TECHNICAL DATA:

- Specifications : 500 W, 230V - 50Hz
- Rating : 30 minutes
- Speed (at no load) : 20000 R.P.M approx.
- Speed Control Switch : Rotary type, 3 Speed with Pulse
- Overload Protection (OLP) : 2.2 Amps rating

Type / Size / Grade / Variety Domestic Electric Food Mixer - Liquidizer/ Grinder 500W, 230V, 50Hz, Single Phase, ac, Class II appliance, Pollution Degree I, Ordinary IPX0, RATING 30 Minutes (Short Terms), Class of Insulation - H . Liquidizer capacity 1.0 Ltrs, Grinder capacity 100 ml, Normal Load 100 grams Urad Dal well soaked in water.

NOT SUITABLE FOR EGG WHISKING TEST.

GENERAL INSTRUCTIONS

- 3 position rotary switch : By turning the switch clockwise you can select the desired speed.
- Pulse function : Turn the switch knob anti clockwise from the OFF position to use the pulse function
- Always turn the switch to the OFF position before storing the appliance for next use, to avoid accidents.

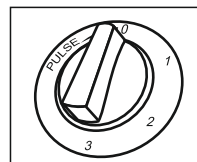

Fig. 1

HOW TO USE

LIQUIDIZING / BLENDING AND GRINDING

The bigger jar with multi purpose 2 leaf blade (refer fig 2) is used for liquidizing/blending & grinding purpose. It can be used for preparation of shakes, purees, idli and dosa batter etc.

- Put all the ingredients to be liquidized or blended in the jar.
- Safely put the jar lid in place.
- Now switch the appliance for operation.

NOTE: JAR CAPACITY: 1.2L MAX. USABLE CAPACITY: 480 ML

- Always ensure proper fixing of the jar lid. Keep a hand on the jar lid while on operation.
- Initially use pulse for better results.
- Do not use this jar for wet grinding.

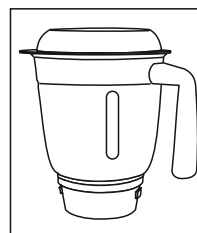

Fig. 2

CHUTNEY JAR

The chutney jar (refer figure 3) is used for for small quantity grinding such as green chutney, red chilli, coconut chutney, pepper etc.

NOTE: JAR CAPACITY: 400 ML MAX. USABLE CAPACITY: 160 ML

- Always ensure proper fixing of the jar lid. Keep a hand on the jar lid while on operation.

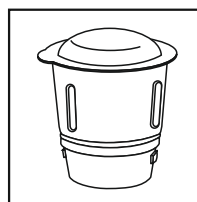

Fig. 3

GRINDING JAR

The grinding jar (refer figure 4) is used for grinding items like garam masala, wet masala, sugar, etc.

- Use small pieces of ingredients for grinding.
- Add water, as per requirement, in case of wet grinding.
- Put the jar lid on top of the jar.
- Grind at "MED" speed for 15-30 seconds and then move to "HIGH" speed.

NOTE: JAR CAPACITY: 800 ML MAX. USABLE CAPACITY: 320 ML

- Always ensure proper fixing of jar lid. Keep a hand on the jar lid while on operation.
- Always move gradually from lower speeds to higher speed.
- During grinding process, the jar might get heated up due to friction. Do not panic. This is normal.

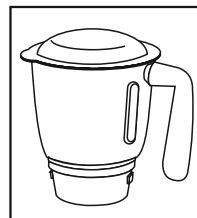

Fig. 4

OVERLOAD PROTECTION (OLP)

- The overload protector (OLP) is designed to protect the motor from burning.
- In case of an overload the blade of the jar stops rotating and the motor gets jammed and starts heating up. The OLP trips off and the motor stops automatically.
- Turn the knob to off position and remove the jar.
- Let the motor cool down for a couple of minutes and then reset the OLP by pressing the red button situated at the bottom of the body.
- If you have to reset the OLP again and again, try reducing the quantity in the jar.

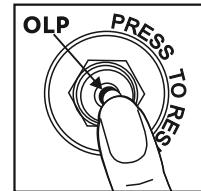

Fig. 5

USE & CARE / PRECAUTION

- Before starting the mixer grinder for the first time or after a long period of non usage, rotate the motor shaft with hand to ensure that it turns freely and smoothly. Make sure the unit is not connected to the electric supply source.
- Similarly rotate the jar coupler to ensure the blade turns freely and smoothly as well.
- Insert the jar collar into the motor body and twist it to lock it in the slot.
- Now plug in the power cord and the mixer grinder is ready for use.
- Do not use your mixer grinder without load and make sure the jar lid is in place before operating the appliance.
- Do not operate the mixer grinder unless the attachments are locked into position.
- Do not burden motor with loads heavier than what is recommended.
- The body of the mixer grinder or the supply cord should never be immersed in water while operation or cleaning.
- Never pull the cord to take out the plug from the socket. Grip the plug and pull out of the socket after duly switching off the power supply.
- Always remove the plug from the power supply before cleaning, while emptying or when not in use.
- Store the appliance in a clean and dry place.

Note : Flat lid and Chutney lid of the jars must be held by hand during the operation.

TIPS

- When using for dry grinding, fill the jar up to the level of the blades.
- When using for wet grinding and blending, fill jars up to 2.5 cm from top of jar.
- When using the blending jar for ice crushing place 6 ice cubes or approximately 2 cups of ice at a time.
- Cut all firm fruits and vegetables into pieces no larger than 1.8 cm (1/2 inch) to 2.5 cm (1 inch). Cut all kinds of cheese into pieces no larger than 1.8 cm (1/2 inch).

Caution : Operate only with lids in place.

GENERAL CLEANING AND CARE FOR THE MIXER GRINDER

- The cleaning of the mixer grinder and jars are very necessary for maintaining smooth operation of the mixer grinder and to maintain proper hygiene.
- After you have used the mixer grinder, use lukewarm water to remove leftover material from the jars and then rinse under running water.

- When removing the blade please keep the washer safely for fitting again.
- The jars can be cleaned by using regular dishwashing soap.
- After thoroughly rinsing the soap, clean the jars with a dry cloth.
- Never store the jars with the lids fitted. This results in problem of odour in jars. For cleaning the body of the mixer grinder, use a soft wet cloth.
- Do not use any detergent/soap solution on the main body.
- Clean the body with a dry cloth before storage for next use.
- Never immerse the motor in the water for cleaning.

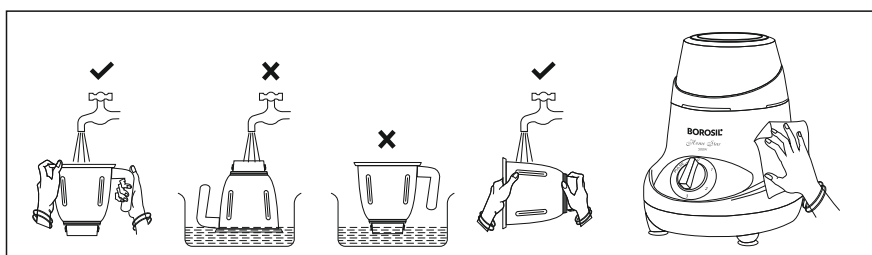

Fig. 6

STANDARD RECIPES

No.	Recipe	Quantity	Time
1	Urad daal	200g + 450ml water soaked for 6-9 hrs. Add 50 ml water	2 min
2	Garam masala	150g of assorted spices roasted and cooled	2 min
3	Wet masala	150g onion + 100g tomato	1.5 min
4	Ginger garlic paste	50g ginger + 50g garlic	1.5 min
5	Milk shake	300ml milk + 50g Ice-cream (optional) + 30g Strawberry crush (sugar as per taste)	1 min
6	Tomato Puree	250g medium sized tomatoes cut in 4's	1.5 min
7	Lassi	250g curd + salt / sugar(as per taste)+crushed ice	30 sec

For wet /dry/chutney grinding use speed LOW and speed MED only for 10-15 seconds. Thereafter use speed HIGH till you finish grinding. Remove the plug from the socket after use.

ENVIRONMENT FRIENDLY DISPOSAL



Correct disposal of this product

To prevent possible harm to the environment or human health from uncontrolled waste disposal, recycle this product responsibly to promote sustainable reuse of material resources.

WARRANTY FOR REPAIR AND SALES

This product comes with a warranty of Five Years on motor, Two Years on product from the date of purchase as specified on the Warranty Card. This is against all defective material or workmanship. In the event of a defect, Borosil Limited at its sole choice, will either repair or replace this product or any component of the product found to be defective free of cost through any Borosil Authorized Service Centre or at customer place or with dealer from whom it has been purchased during the warranty period.

For any information or problem, contact Borosil Customer Care Toll free no. **1800 224 552** or e-mail us at **myborosil@borosil.com** or contact your local dealer or **Borosil Authorized Service Centre** and provide information about the defect with the model number and the serial number of the product.

The warranty is not valid in case :

1. Product is not used according to user manual.
2. Defects caused by improper or reckless use.
3. Repairs done by persons other than Borosil Authorized Service Centre.
4. Modifications of any nature made in the product.
5. Tampered serial number and incomplete warranty card after purchase.
6. Product if used for commercial purpose (i.e. other than domestic use)
7. Usage of parts not recommended by Borosil or those made by other manufacturers.
8. The model no. on the invoice is different from the product to be repaired
9. Borosil is not responsible for accidents arising due to the use of accessories not designed for the utilisation with this product.
10. If the defects are caused by fire, flood and the other act of god.
11. If the defects are caused by use of incorrect current or voltage or faulty electric power supply.
12. All consumables and parts susceptible to normal wear & tear are not covered under warranty.
13. This warranty does not cover damage or injury caused by accident, mishandling, misuse or normal wear and tear or for loss of injury, directly or indirectly arising out of use of this product. The decision of the company in this regard shall be final.
14. If the product is used with any type of adapter or connector.
15. If the product is used in locations with different electrical specifications.

WARRANTY CARD		BOROSIL®
THIS CARD IS VALID ONLY IF IT IS FILLED IN COMPLETELY, SIGNED AND STAMPED BY THE DEALER ON THE DATE OF PURCHASE		
MODEL CODE :	HAMG500W22	
CUSTOMER'S NAME :	_____	
ADDRESS :	_____	
PHONE NO. RESIDENCE :	_____	OFFICE : _____
DATE OF PURCHASE & BILL NO. :	_____	
DEALER NAME & SIGN :	_____	
CUSTOMER'S SIGNATURE :	_____	
DEALER'S STAMP		

BOROSIL®

CORPORATE OFFICE:

BOROSIL LIMITED

1101, G-Block, Crescenzo, BKC, Bandra (East), Mumbai- 400 051, Maharashtra.

Website: www.myborosil.com | **Customer Care Toll Free No.:** 1800 224 552 / 1800 2106 520

Email id: myborosil@borosil.com | Tel.: 022 6740 6300 | Fax: 022 6740 6514

CIN No.: L36100MH2010PLC292722

SALES OFFICE:

MUMBAI:

Kanakia Zillion, B-Wing, Unit No. 306, L.B.S Marg, Next to Kurla Bus Depot, Kurla (W),

Mumbai- 400 070. | Tel.: 022 6740 6400 | Fax: 022 6740 6444

email id: mumbaisales@borosil.com

DELHI:

19/90, P-Block, Connaught Place (Madras Hotel Block), New Delhi- 110 001.

Tel.: 011 2334 3897 | Fax: 011 2374 6689 | email id: delhi@borosil.com

CHENNAI:

NEW No. 20, (Old No. 9) 1st Floor, Brahadammal Road, Nungambakkam, Chennai- 600 034.

Tel.: 044 2822 6012 / 2822 6013 | Fax: 044 2822 6014

email id: borosilms@ethnet / chennai@borosil.com

KOLKATA:

E-2/3, 2nd Floor, Gilander House, Netaji Subhash Road, Kolkata, West Bengal- 700 001.

Tel.: 033 2229 9166 / 2226 2045 | email id: calcutta@borosil.com

GURUGRAM:

201, 2nd Floor, CRS Towers, Plot No. 77-B, Village Sarhaul, Iffco Road, Sector- 18, Gurugram,

Haryana- 122 015. | Tel.: 0124 6926 333

BENGALURU:

Spatium South Park, 54, 1st Floor, 1st Main Rd, Sarakki Industrial Layout, Dollar Layout, 3rd Phase,

J. P. Nagar, Bengaluru, Karnataka 560078.

email id: bangalore@borosil.com

**GOT A SERVICE-RELATED QUERY OR
NEED CUSTOMER SUPPORT?**



SCAN THE QR CODE & PLACE YOUR
SERVICE REQUEST ON WHATSAPP 24 x 7
+91 7208487334

TOLL FREE NUMBER

**1800 224 552 /
1800 2106 520**

Shop online at www.myborosil.com | Follow us on    Borosil And You